

evOLUTION®

www.evolutionpowertools.com

RAGE 4

- EN Original Instructions
- ES Instrucciones Originales
- FR Notice Originale



TABLE OF CONTENTS

INTRODUCTION	Page 3	OPERATING INSTRUCTIONS	Page 16
Guarantee	Page 3	Preparing to Make a Cut	Page 16
Machine Specifications	Page 4	The On/Off Trigger Switch	Page 17
Vibration	Page 5	Making a Cut	Page 17
Labels and Symbols	Page 5		
Intended use of this Power Tool	Page 6	MAINTENANCE	Page 17
Prohibited use of this Power Tool	Page 6	Checking/Replacing the Carbon Brushes	Page 18
		Transportation/Storage	Page 18
SAFETY PRECAUTIONS	Page 7		
Electrical Safety	Page 7	ENVIRONMENTAL PROTECTION	Page 18
Outdoor Use	Page 7		
General Power Tool Safety Instructions	Page 7	DECLARATION OF CONFORMITY	Page 19
Health Advice	Page 9		
Additional Safety Instructions - Chop Saws	Page 9		
GETTING STARTED	Page 11		
Unpacking	Page 11		
Items Supplied	Page 11		
Additional Accessories	Page 11		
MACHINE OVERVIEW	Page 12		
Figure Diagrams	Page 13		
Releasing the Cutting Head	Page 14		
Installing or Removing a Blade	Page 14		
Cutting Angle Adjustment	Page 14		
Dust Extraction Port	Page 15		
Speed Handle	Page 15		
Repositioning the Rear Vice Jaw	Page 15		

INTRODUCTION

(1.2) This instruction manual was originally written in English.

(1.3)

IMPORTANT

Please read these operating and safety instructions carefully and completely. For your own safety, if you are uncertain about any aspect of using this equipment please access the relevant Technical Helpline, the number of which can be found on the Evolution Power Tools website. We operate several Helplines throughout our worldwide organization, but Technical help is also available from your supplier.

WEB

www.evolutionpowertools.com

EMAIL

evolutioninfo@evolutionpowertools.com

(1.4)

Congratulations on your purchase of an Evolution Power Tools Machine. Please complete your product registration 'online' as explained in the A4 online guarantee registration leaflet included with this machine. You can also scan the QR code found on the A4 leaflet with a Smart Phone. This will enable you to validate your machine's guarantee period via Evolutions website by entering your details and thus ensure prompt service if ever needed. We sincerely thank you for selecting a product from Evolution Power Tools.

EVOLUTION LIMITED WARRANTY

Evolution Power Tools reserves the right to make improvements and modifications to the product design without prior notice. Please refer to the warranty registration leaflet and/or the packaging for details of the terms and conditions of the warranty. The warranty below is applicable to machines destined for the UK mainland

market only. Other markets may have specific requirements, additions or exclusions applied. Consult your dealer for details of the warranty applied to your area/country. Evolution's warranty is in addition to your statutory rights.

MACHINE SPECIFICATIONS

MACHINE SPECIFICATIONS	METRIC	IMPERIAL
Motor AUS/EU (230-240V ~ 50/60 Hz)	1250W	6A
Motor UK (110V ~ 50/60 Hz)	1250W	6A
Motor USA (120V ~ 50Hz)	1250W	10A
No Load Speed	UK/EU 4500min ⁻¹	4200rpm
Weight	9.1Kg	20.1lbs

CUTTING CAPACITIES	METRIC	IMPERIAL
Mild Steel Plate (Max Thickness)	6mm	1/4"
Mild Steel Box Section (Max Wall Thickness)	3mm	1/8"
Mild Steel Box Section	45 x 45mm	1 - 3/4" x 1 - 3/4"
Mild Steel Round Section Tube (at 90°):	50mm	2"
Max Cutting Capacity (Wood 90°)	45 x 97mm	1 - 3/4" x 3 - 3/4"
Max Cutting Capacity (Wood 45°)	40 x 40mm	1 - 5/8" x 1 - 5/8"
Minimum Size Work-Piece	152mm	6"

BLADE SPECIFICATIONS	METRIC	IMPERIAL
Diameter	185mm	7-1/4"
Bore Diameter	20mm	25/32"
Max Blade Speed	5000min ⁻¹	5000rpm
Thickness	1.7mm	.067"

NOISE & VIBRATION DATA	
Sound Pressure L _{PA} (Under Load)	93dB(A) K=3dB(A)
Sound Power Level L _{WA} (Under Load)	106dB(A) K=3dB(A)
Vibration Level (Under Load)	4,5 m/s ² K=1,5 m/s ²

(1.6)

Note: The vibration measurement was made under standard conditions in accordance with: BS EN 61029-1:2009

The declared vibration total value has been measured in accordance with a standard test method and may be used for comparing one tool with another.

The declared vibration total value may also be used in a preliminary assessment of exposure.

(1.7)

VIBRATION

WARNING: When using this machine the operator can be exposed to high levels of vibration transmitted to the hand and arm. It is possible that the operator could develop "Vibration white finger disease" (Raynaud syndrome). This condition can reduce the sensitivity of the hand to temperature as well as producing general numbness. Prolonged or regular users of this machine should monitor the condition of their hands and fingers closely. If any of the symptoms become evident, seek immediate medical advice.

- The measurement and assessment of human exposure to hand-transmitted vibration in the workplace is given in: BS EN ISO 5349-1:2001 and BS EN ISO 5349-2:2002
- Many factors can influence the actual vibration level during operation e.g. the work surfaces condition and orientation and the type and condition of the machine being used. Before each use, such factors should be assessed, and where possible appropriate working practices adopted. Managing these factors can help reduce the effects of vibration:

Handling

- Handle the machine with care, allowing the machine to do the work.
- Avoid using excessive physical effort on any of the machines controls.
- Consider your security and stability, and the orientation of the machine during use.

Work Surface

- Consider the work surface material; its condition, density, strength, rigidity and orientation.

WARNING: The vibration emission during actual use of the power tool can differ from the declared total value depending on the ways in which the tool is used. The need to identify safety measures and to protect the operator are based on an estimation of exposure in the actual conditions of use (taking account of all parts of the operating cycle, such as the times the tool is switched off, when it is running idle, in addition to trigger time).

(1.8)

LABELS & SYMBOLS

WARNING: Do not operate this machine if warning and/or instruction labels are missing or damaged. Contact Evolution Power Tools for replacement labels.

Note: All or some of the following symbols may appear in the manual or on the product.

(1.9)

Symbol	Description
V	Volts
A	Amperes
Hz	Hertz
Min ⁻¹	Speed
~	Alternating Current
n ₀	No Load Speed
	Wear Safety Goggles
	Wear Ear Protection
	Wear Dust Protection
	Read Instructions
	CE Certification
	CSA Certification
	Waste Electrical & Electronic Equipment
	Triman - Waste Collection & Recycling
	Warning
	Double Insulation Protection
	(RCM) Regulatory Compliance Mark for electrical and electronic equipment. Australian/New Zealand Standard

(1.10)

INTENDED USE OF THIS POWER TOOL

WARNING: This product is a Hand Operated Chop Saw and has been designed to be used with special **Evolution** blades. Only use accessories designed for use in this machine and/or those recommended specifically by **Evolution Power Tools Ltd.**

When fitted with an appropriate blade this machine can be used to cut:

- Mild Steel
- Aluminium
- Wood

Note: Cutting galvanised steel may reduce blade life.

(1.11)

PROHIBITED USE OF THIS POWER TOOL

WARNING: This product is a Hand Operated Chop Saw and must only be used as such. It must not be modified in any way, or used to power any other equipment or drive any other accessories other than those mentioned in this Instruction Manual.

(1.13)

WARNING: This machine is not intended for use by persons (including children) with reduced physical, sensory or mental capabilities, or lack of experience and knowledge, unless they have been given supervision or instruction concerning the safe use of the machine by a person responsible for their safety and who is competent in its safe use.

Children should be supervised to ensure that they do not have access to, and are not allowed to play with, this machine.

(1.14)

ELECTRICAL SAFETY

This machine is fitted with the correct moulded plug and mains lead for the designated market. If the supply cord is damaged, it must be replaced by a special cord or assembly available from the manufacturers or its service agent.

(1.15)

OUTDOOR USE

WARNING: For your protection if this tool is to be used outdoors it should not be exposed to rain, or used in damp locations. Do not place the tool on damp surfaces. Use a clean, dry workbench if available. For added protection use a residual current device (R.C.D.) that will interrupt the supply if the leakage current to earth exceeds 30mA for 30ms. Always check the operation of the residual current device (R.C.D.) before using the machine.

If an extension cable is required it must be a suitable type for use outdoors and so labelled.

The manufacturers instructions should be followed when using an extension cable.

(2.1)

POWER TOOL GENERAL SAFETY INSTRUCTIONS

(These General Power Tool Safety Instructions are as specified in BS EN 60745-1:2009 & EN 61029-1:2009)

WARNING: Read all safety warnings and instructions. Failure to follow the warnings and instructions may result in electric shock, fire and/ or serious injury.

Save all warnings and instructions for future reference.

The term "power tool" in the warnings refers to your mains-operated (corded) power tool or battery-operated (cordless) power tool.

(2.2)

1) General Power Tool Safety Warnings

[Work area safety]

- a) Keep work area clean and well lit.** Cluttered or dark areas invite accidents.
- b) Do not operate power tools in explosive atmospheres, such as in the presence of flammable liquids, gasses or dust.** Power tools create sparks which may ignite the dust or fumes.
- c) Keep children and bystanders away while operating power tool.** Distractions can cause you to lose control.

(2.3)

2) General Power Tool Safety Warnings

[Electrical Safety]

- a) Power tool plugs must match the outlet. Never modify the plug in any way Do not use any adapter plugs with earthed (grounded) power tools.** Unmodified plugs and matching outlets will reduce the risk of electric shock.
- b) Avoid body contact with earthed or grounded surfaces, such as pipes, radiators, ranges and refrigerators.** There is an increased risk of electric shock if your body is earthed or grounded.
- c) Do not expose power tools to rain or wet conditions.** Water entering a power tool will increase the risk of electric shock.
- d) Do not abuse the cord. Never use the cord for carrying, pulling or unplugging the power tool. Keep cord away from heat, oil, sharp edges or moving parts.** Damaged or entangled cords increase the risk of electric shock.
- e) When operating a power tool outdoors, use an extension cord suitable for outdoor use.** Use of a cord suitable for outdoor use reduces the risk of electric shock.
- f) If operating a power tool in a damp location is unavoidable, use a residual current device (RCD) protected supply.** Use of an RCD reduces the risk of electric shock.

(2.4)

3) General Power Tool Safety Warnings [Personal Safety].

a) Stay alert, watch what you are doing and use common sense when operating a power tool. Do not use a power tool while you are tired or under the influence of drugs, alcohol or medication. A moment of inattention while operating power tools may result in serious personal injury.

b) Use personal protective equipment. Always wear eye protection. Protective equipment such as dust masks, non-skid safety shoes, hard hat or hearing protection used for appropriate conditions will reduce personal injuries.

c) Prevent unintentional starting. Ensure the switch is in the off-position before connecting to power source and or battery pack, picking up or carrying the tool. Carrying power tools with your finger on the switch or energising the power tools that have the switch on invites accidents.

d) Remove any adjusting key or wrench before turning the power tool on. A wrench or key left attached to a rotating part of a power tool may result in personal injury.

e) Do not overreach. Keep proper footing and balance at all times. This enables better control of the power tool in unexpected situations.

f) Dress properly. Do not wear loose clothing or jewellery. Keep your hair, clothing and gloves away from moving parts. Loose clothes, jewellery or long hair can be caught in moving parts.

g) If devices are provided for the connection of dust extraction and collection facilities, ensure that these are connected and properly used. Use of dust collection can reduce dust-related hazards.

(2.5)

4) General Power Tool Safety Warnings [Power tool use and care].

a) Do not force the power tool. Use the correct power tool for your application.

The correct power tool will do the job better and safer at a rate for which it was designed.

b) Do not use the power tool if the switch does not turn it on or off. Any power tool that cannot be controlled with the switch is dangerous and must be repaired.

c) Disconnect the power tool from the power source and/or battery pack from the power tool before making any adjustments, changing accessories, or storing power tools. Such preventative safety measures reduce the risk of starting the power tool accidentally.

d) Store idle power tools out of the reach of children and do not allow persons unfamiliar with the power tool or these Instructions to operate the power tool. Power tools are dangerous in the hands of untrained users.

e) Maintain power tools. Check for misalignment or binding of moving parts, breakage of moving parts and any other condition that may affect the power tools operation. If damaged, have the power tool repaired before use. Many accidents are caused by poorly maintained power tools.

f) Keep cutting tools sharp and clean. Properly maintained cutting tools with sharp cutting edges are less likely to bind and are easier to control.

g) Use the power tool, accessories and tool bits etc. in accordance with these instructions, taking into account the working conditions and the work to be performed. Use of the power tool for operations different from those intended could result in a hazardous situation.

(2.6)

5) General Power Tool Safety Warnings [Service]

a) Have your power tool serviced by a qualified repair person using only identical replacement parts. This will ensure that the safety of the power tool is maintained.

(2.7) HEALTH ADVICE

WARNING: When using this machine, dust particles may be produced. In some instances, depending on the materials you are working with, this dust can be particularly harmful. If you suspect that paint on the surface of material you wish to cut contains lead, seek professional advice. Lead based paints should only be removed by a professional and you should not attempt to remove it yourself. Once the dust has been deposited on surfaces, hand to mouth contact can result in the ingestion of lead. Exposure to even low levels of lead can cause irreversible brain and nervous system damage. The young and unborn children are particularly vulnerable.

You are advised to consider the risks associated with the materials you are working with and to reduce the risk of exposure. As some materials can produce dust that may be hazardous to your health, we recommend the use of an approved face mask with replaceable filters when using this machine.

You should always:

- Work in a well-ventilated area.
- Work with approved safety equipment, such as dust masks that are specially designed to filter microscopic particles.

(2.8)

WARNING: The operation of any power tool can result in foreign objects being thrown towards your eyes, which could result in severe eye damage. Before beginning power tool operation, always wear safety goggles or safety glasses with side shield or a full face shield where necessary.

(3.0)

ADDITIONAL SAFETY INSTRUCTIONS

(3.1)

a) DANGER: Keep hands away from cutting area and the blade. Keep your second hand on auxiliary handle, or motor housing.

If both hands are holding the saw, they cannot be cut by the blade.

b) Do not reach underneath the workpiece.

The guard cannot protect you from the blade below the workpiece.

c) Adjust the cutting depth to the thickness of the workpiece. Less than a full tooth of the blade teeth should be visible below the workpiece.

d) Never hold piece being cut in your hands or across your leg. Secure the workpiece to a stable platform. It is important to support the work properly to minimize body exposure, blade binding, or loss of control.

e) Hold power tool by insulated gripping surfaces when performing an operation where the cutting tool may contact hidden wiring or its own cord. Contact with a "live" wire will also make exposed metal parts of the power tool "live" and shock the operator.

f) When ripping always use a rip fence or straight edge guide. This improves the accuracy of cut and reduces the chance of blade binding.

g) Always use blades with correct size and shape (diamond versus round) of arbor holes. Blades that do not match the mounting hardware of the saw will run eccentrically, causing loss of control.

h) Never use damaged or incorrect blade washers or bolt. The blade washers and bolt were specially designed for your saw, for optimum performance and safety of operation.

i) Do not use High Speed Steel (HSS) saw blades.

j) Inspect the machine and the blade before each use. Do not use deformed, cracked, worn or otherwise damaged blades.

k) Never use the saw without the original guard protection system. Do not lock the moving guard in the open position. Ensure that the guard operates freely without jamming.

l) Only use blades that comply with the characteristics specified in this manual. Before using accessories, always compare the maximum allowed RPM of the accessory with the RPM of the machine.

(3.2)

Causes and operator prevention of kickback:

Kickback is a sudden reaction to a pinched, bound or misaligned saw blade, causing an uncontrolled saw to lift up and out of the workpiece toward the operator:

1. When the blade is pinched or bound tightly by the kerf closing down, the blade stalls and the motor reaction drives the unit rapidly back toward the operator;
2. If the blade becomes twisted or misaligned in the cut, the teeth at the back edge of the blade can dig into the top surface of the workpiece causing the blade to climb out of the kerf and jump back towards the operator.

(3.3)

Kickback is the result of saw misuse and/or incorrect operating procedures or conditions and can be avoided by taking proper precautions as given below.

- a) **Maintain a firm grip with both hands on the saw and position your arms to resist kickback forces. Position your body to either side of the blade, but not in line with the blade.** Kickback could cause the saw to jump backwards, but kickback forces can be controlled by the operator, if proper precautions are taken.
- b) **If the blades are binding, or when interrupting a cut for any reason, release the trigger and hold the saw motionless in the material until the blades come to a complete stop. Never attempt to remove the saw from the work or pull the saw backward while the blades are in motion or kickback may occur.** Investigate and take corrective actions to eliminate the cause of blade binding.
- c) **When restarting a saw in the workpiece, centre the saw blade in the kerf and check that saw teeth are not engaged into the material.** If saw blade is binding, it may walk up or kickback from the workpiece as the saw is restarted.
- d) **Support large panels to minimise the risk of blade pinching and kickback.**

Large panels tend to sag under their own weight. Supports must be placed under the panel on both sides, near the line of cut and near the edge of the panel.

- e) **Blade depth and bevel adjusting locking levers must be tight and secure before making a cut.** If the blade adjustment shifts while cutting it may cause binding and kickback.
- f) **Do not use dull or damaged blades.** Unsharpened or improperly set blades produce a narrow kerf causing excessive friction, blade binding and kickback.
- g) **Use extra caution when making a “plunge cut” into existing walls or other blind areas.** The protruding blade may cut objects that can cause kickback.
- h) **Check lower guard for proper closing before each use. Do not operate the saw if lower guard does not move freely and close instantly. Never clamp or tie the lower guard into the open position.** If saw is accidentally dropped, lower guard may be bent. Raise the lower guard with the retracting handle and make sure it moves freely and does not touch the blade or any other part, in all angles and depths of cut.
- i) **Check the operation of the lower guard spring. If the guard and the spring are not operating properly, they must be serviced before use.** Lower guard may operate sluggishly due to damaged parts, gummy deposits, or a build-up of debris.
- j) **Lower guard may be retracted manually only for special cuts such as “plunge cuts” and “compound cuts.” Raise lower guard by retracting handle and as soon as blade enters the material, the lower guard must be released.** For all other sawing, the lower guard should operate automatically.
- k) **Always observe that the lower guard is covering the blade before placing saw down on a bench or the floor.** An unprotected, coasting blade will cause the saw to walk backwards, cutting whatever is in its path. Be aware of the time it takes for the blade to stop after switch is released.

(3.4)

WARNING: If any parts are missing, do not operate your machine until the missing parts are replaced. Failure to follow this rule could result in serious personal injury.

(4.1)**GETTING STARTED - UNPACKING**

Caution: This packaging contains sharp objects. Take care when unpacking. Remove the machine, together with the accessories supplied from the packaging. Check carefully to ensure that the machine is in good condition and account for all the accessories listed in this manual. Also make sure that all the accessories are complete. If any parts are found to be missing, the machine and its accessories should be returned together in their original packaging to the retailer. Do not throw the packaging away; keep it safe throughout the guarantee period. Dispose of the packaging in an environmentally responsible manner. Recycle if possible. Do not let children play with empty plastic bags due to the risk of suffocation.

(4.2)**ITEMS SUPPLIED**

Description	Quantity
Instruction Manual	1
Multipurpose Blade (Fitted)	1
Hex Key 6mm (Vice Adjustment)	1
Hex Key 5mm (Blade Change)	1
Hex Key 3mm (Upper Blade Guard)	1
Dust Extraction Port	1
Rubber Vice Jaw Protector	1
Speed Handle	1
Spare Motor Brushes	1 set

(4.3)**ADDITIONAL ACCESSORIES**

In addition to the standard items supplied with this machine the following accessories are also available from the Evolution online shop at www.evolutionpowertools.com or from your local retailer.

(4.4)

Description	Part No
Multipurpose Blade	RAGEBLADE185MULTI
Diamond Blade	RAGEBLADE185DIAMOND

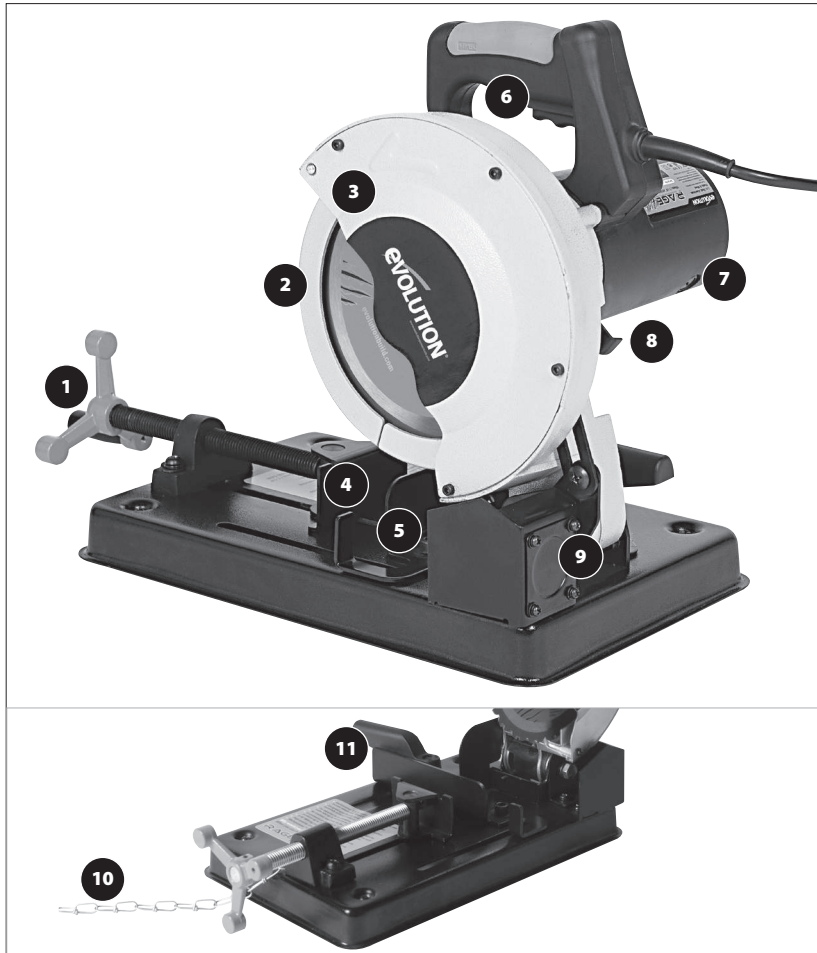
MACHINE OVERVIEW

- | | |
|---------------------------------------|--|
| 1. FRONT VICE HAND WHEEL | 7. MOTOR / CARBON BRUSHES |
| 2. LOWER BLADE GUARDS | 8. ARBOR LOCK BUTTON |
| 3. UPPER BLADE GUARD | 9. DUST EXTRACTION PORT |
| 4. SWIVELLING FRONT VICE JAW | 10. LOCK DOWN CHAIN |
| 5. ADJUSTABLE REAR VICE JAW | 11. LEVER HANDLED LOCKING SCREW |
| 6. HANDLE & TRIGGER SWITCH | |



Fig. 1

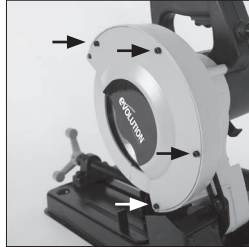

Fig. 2

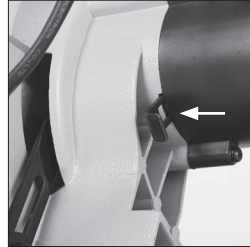

Fig. 3

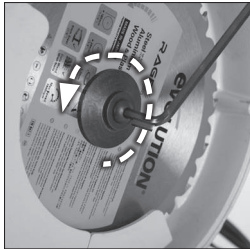

Fig. 4

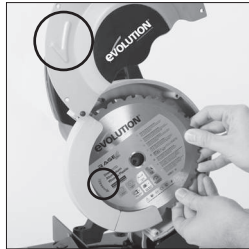

Fig. 5

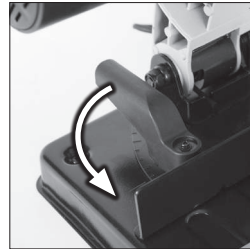

Fig. 6

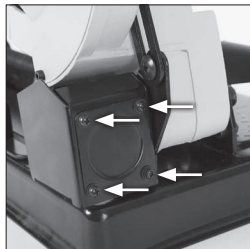

Fig. 7



Fig. 8

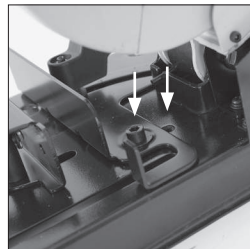

Fig. 9

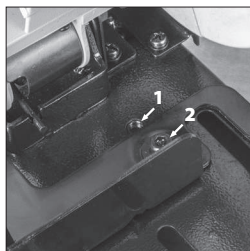

Fig. 10

RELEASING THE CUTTING HEAD

The cutting head will automatically rise to the upper position once it is released from the locked down position.

To release the cutting head from the locked down position:

- Gently press down on the cutting handle.
- Unhook the lock down chain from the lock down hook. **(Fig. 1)**. Allow the cutting head to rise to its upper position.

Note: We recommend that when the machine is not in use the cutting head is locked in the down position with the lock down chain engaged with the lock down hook.

INSTALLING OR REMOVING A BLADE

WARNING: Only use genuine Evolution blades, or Evolution approved blades which are designed for this machine. Ensure that the maximum speed of the blade is compatible with the machine.

WARNING: Only perform this operation with the machine disconnected from the power supply.

Note: It is recommended that the operator considers wearing protective gloves when handling the blade during installation or when changing the machines blade.

Removing a blade:

- Ensure that the cutting head is in its upper position.
- Remove the four (4) socket headed screws securing the upper blade guard and rotate the guard to reveal the machines arbor. **(Fig. 2)**
- Engage the arbor lock by pressing the arbor lock button underneath the rear of the motor housing. **(Fig. 3)**
- Use the supplied hex key to loosen the arbor screw. **(Fig. 4)**

Note: The arbor screw has a right hand thread. Turn clockwise to tighten. Turn counterclockwise to loosen.

- Remove the arbor screw, washer and outer blade flange and store safely for future installation.
- Remove the blade, leaving the inner blade flange in its service position.

Installing a Blade:

- Ensure that all components are free from dirt and debris.
- Install the blade onto the inner blade flange and arbor, ensuring that the direction and rotation arrow on the blade matches the direction of arrow rotation found on the machines upper blade guard. **(Fig. 5)**
- Reinstall the outer blade flange, washer and arbor screw.
- Lock the arbor by pressing the arbor lock button and tighten the arbor screw using the 6mm Hex Key.
- Return the upper blade guard to its service position and replace and tighten the four (4) socket headed screws.
- Check that the arbor lock has been released by rotating the blade by hand.
- Ensure that the hex key is removed from the arbor screw and is safely stored for future use.
- Check the installation, and particularly the operation of the retractable lower blade guards by lowering and raising the cutting head a few times.

WARNING: After installing a new blade, always run the machine, without load, for a couple of minutes. Stand away from the blade. If the blade were to contain an undetected flaw, it could shatter during this trial run.

CUTTING ANGLE ADJUSTMENT

Note: The rear vice jaw can be turned through an angle of up to 45° in position 2 (Hole to the front), no access to 45 degree in position 1. **(Fig. 10)**

The rear vice jaw is factory set at 0° (at 90° to the blade) so that the blade cuts squarely across material positioned in the vice.

For angled cuts, the rear vice jaw can be swung through (up to) 45°, with a protractor scale being included on the vice jaw for ease and accuracy of setting.

To angle the rear vice jaw:

- Loosen the lever handled locking screw and the RH socket headed screw (**Fig. 6**)
- Turn the rear vice jaw to the required angle.
- Tighten the RH socket headed screw securely using the supplied hex key.
- Tighten the lever handled locking screw.

Note: The lever handled locking screw has a repositionable lever. Repositioning of the lever may be necessary to ensure that the locking screw can be tightened sufficiently when the rear vice jaw is angled.

To reposition the lever:

- Remove the cross-headed screw that secures the lever to the screw.
- Lift the lever off the hexagonal screw head.
- Reposition the lever as necessary and replace the cross-headed screw.

Note: The swivelling front vice jaw will automatically align with, and/or compensate for, any angle to which the rear vice jaw is set. The swivelling front vice jaw also allows irregular shaped work-pieces to be accommodated in the vice.

Note: A rubber vice jaw protector can be attached to the swivelling front vice jaw. This protector will help with the security of the workpiece held in the vice and also help prevent damage to the gripped workpiece.

DUST EXTRACTION PORT

WARNING: Dust can potentially be a danger to the machines operator and to any nearby colleagues.

We recommend that if you intend to use this machine to cut material(s) that create dust (timber, plywood, certain plastics etc.) that the dust extraction port is fitted to the machine.

This will then allow a workshop dust extraction system to be connected to the machine. The operator should also wear a suitable dust mask, and any other relevant PPE (Personal Protective Equipment).

To fit the dust extraction port:

- Remove the four cross-headed screws and their associated washers from the blanking plate at the rear of the machine. (**Fig. 7**)
- Remove the blanking plate.
- Using the four removed screws fit the dust extraction port in place of the blanking plate.

Note: When using a dust extraction system with this machine follow the instructions supplied with the dust extraction system regarding safe operating procedures.

SPEED HANDLE

Note: One (1) of the arms of the tri-armed vice tightening/loosening hand-wheel is drilled and threaded.

Fit the 'Speed Handle' if desired to the vice hand-wheel. The handle simply screws into the threaded hole found in one of the hand-wheel arms. (**Fig. 8**) Use a cross-headed screwdriver to tighten the handle into its service position.

REPOSITIONING THE REAR VICE JAW

The rear vice jaw can be removed from the machines base and repositioned. (**Fig.9**)

Note: There are two (2) possible positions available because of the four (4) threaded holes in the machines base.

To reposition:

- Remove the RH socket headed screw that secures the rear vice jaw to the machines base.
- Remove the lever handled locking screw and all washers that secure the rear vice jaw to the machines base.

Fig. 10

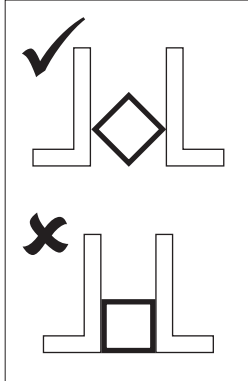

To remove the lever handled locking screw:

- Remove the cross-headed screw that secures the lever handle to the locking screw.
- Lift the lever handle off the hexagonal locking screw head.
- Using a suitable spanner (not supplied) remove the locking screw and its associated washer from the machines base.
- Lift the rear vice jaw from the machines base.
- Reposition the vice jaw.
- Replace the socket headed screw into its new service position.
- Replace the locking screw and its lever handle into their new service positions.
- Ensure that all plain and locking washers are replaced in their correct service positions.

Note: Repositioning the rear vice jaw to the rearmost position will enable wider pieces of material to be cut than is possible with the rear vice jaw in the forward position.

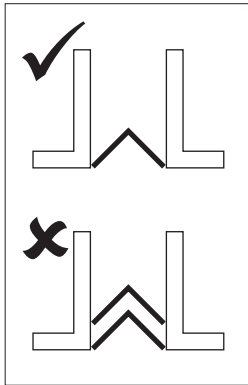

OPERATING INSTRUCTIONS

PREPARING TO MAKE A CUT

Do not overreach. Keep good footing and balance. Stand to one side so that your face and body are out of line of a possible kickback.

WARNING: Freehand cutting is a major cause of accidents and should not be attempted.

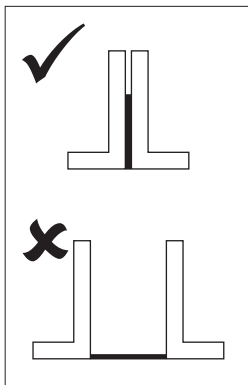

- Ensure that the work-piece is firmly secured in the vice.
- The machines base should be clean and free from any 'swarf' or sawdust, etc, before the work-piece is clamped into position.
- Ensure that the 'cut-off' material is free to move sideways away from the blade when the cut is completed. Ensure that the 'cut-off' piece cannot become 'jammed' in any other part of the machine.
- Do not use this saw to cut small pieces. If the work-piece being cut would cause your hand or fingers to be within 150mm of the sawblade, the work-piece is too small.

Angles should be clamped in an inverted position (**Fig.10**) so that the point of the section is uppermost.

THE ON/OFF TRIGGER SWITCH

This machine is equipped with a safety start trigger switch.

To start the motor:

- Push in the safety lock button on the side of the handle with your thumb.
- Depress the main trigger switch to start the motor.

WARNING: Never start the saw with the cutting edge of the saw blade in contact with the work-piece surface.

WARNING: Before leaving the machine, ensure that the machine and the blade rotation has come to a complete stop. An unattended, live machine is unpredictable and highly dangerous to people in the vicinity.

MAKING A CUT

- With the cutting head in the upper position, switch on the motor and allow it to reach full operational speed.
- Gently lower the cutting head.
- Introduce the blade into the material slowly, using light pressure at first to keep the blade from grabbing.
- Gradually increase the pressure as a blade enters the work-piece. Do not 'force' the machine. Let the saw blade do the work.

Note: Cutting performance will not improve by applying undue pressure on the machine, and doing so may cause blade and motor life to be reduced.

- Reduce the pressure as the blade begins to exit the material.
- On completion of a cut allow the cutting head to return to its upper position, and turn off the motor.
- Only remove your hands, or the work-piece from the machine, after the motor has completely stopped and the stationary blade is covered by the lower blade guard.

MAINTENANCE

Note: Any maintenance must be carried out with the machine switched off and disconnected from the mains/battery power supply.

Check that all safety features and guards are operating correctly on a regular basis. Only use this machine if all guards/safety features are fully operational.

All motor bearings in this machine are lubricated for life.

No further lubrication is required.

Use a clean, slightly damp cloth to clean the plastic parts of the machine. Do not use solvents or similar products which could damage the plastic parts.

WARNING: Do not attempt to clean by inserting pointed objects through openings in the machines casings etc. The machines air vents should be cleaned using compressed dry air.

Excessive sparking may indicate the presence of dirt in the motor or worn out carbon brushes.

CHECKING/REPLACING THE CARBON BRUSHES

WARNING: Disconnect the machine from the power supply before attempting to check or replace the carbon brushes. Replace both carbon brushes if either has less than 6mm length of carbon remaining, or if the spring or wire is damaged or burned.

To remove the brushes:

- Unscrew the plastic caps found at the back of the motor. Be careful as the caps are spring-loaded.
- Withdraw the brushes with their springs.
- If replacement is necessary renew the brushes and replace the caps.

Note: Used but serviceable brushes can be replaced, but only as long as they are returned to the same position, and inserted the same way round, as they were removed from the machine.

- Run new brushes without load for approximately 5 minutes. This will help the bedding-in process.

TRANSPORTATION/STORAGE

For ease and convenience, when transporting or storing the machine, the cutting head can be held in the 'down' position.

To hold the cutting head down:

- Lower the cutting head to its lowest position.
- Hook the requisite link of the lock down chain over the lock down hook.

(6.4)

ENVIRONMENTAL PROTECTION

Waste electrical products should not be disposed of with household waste. Please recycle where facilities exist. Check with your local authority or retailer for recycling advice.



EC DECLARATION OF CONFORMITY

In accordance with EN ISO 17050-1:2004



The manufacturer of the product covered by this Declaration is:

Evolution Power Tools, Venture One, Longacre Close, Holbrook Industrial Estate, Sheffield, S20 3FR.

The manufacturer hereby declares that the machine as detailed in this declaration fulfils all the relevant provisions of the Machinery Directive and other appropriate directives as detailed below. The manufacture further declares that the machine as detailed in this declaration, where applicable, fulfils the relevant provisions of the Essential Health and Safety requirements.

The Directives covered by this Declaration are as detailed below:

2006/42/EC.	Machinery Directive.
2014/30/EU.	Electromagnetic Compatibility Directive.
2011/65/EU.	The Restriction of the Use of certain Hazardous Substances in Electrical Equipment (RoHS) Directive.
2002/96/EC as amended by 2003/108/EC .	The Waste Electrical and Electronic Equipment (WEEE) Directive.

And is in conformity with the applicable requirements of the following documents:

**EN ISO 16093: 2017 • EN60204-1:2006/A1: 2009 • AfPS GS 2014:01 PAK
EN55014-1: 2006/A2:2011 • EN55014-2: 2015 • EN61000-3-2: 2014 • EN61000-3-3:2013**

Product Details

Description: RAGE4 185mm (7-1/4") MULTIPURPOSE CHOP SAW
Evolution Model No: UK 230V: 081-0006, UK 110V: 081-0007, USA 120V: 081-0009,
EU 230V: 081-0008
Brand Name: EVOLUTION
Voltage: 230-240V / 110V / 120V ~ 50/60Hz
Input: 1250W

The technical documentation required to demonstrate that the product meets the requirements of directive has been compiled and is available for inspection by the relevant enforcement authorities, and verifies that our technical file contains the documents listed above and that they are the correct standards for the product as detailed above.

Name and address of technical documentation holder.

Signed:  Print: Matthew Gavins - Group Chief Executive

Date: 03/03/16

evOLUTION®

evolutionpowertools.com

UK

Evolution Power Tools Ltd
Venture One
Longacre Close
Holbrook Industrial Estate
Sheffield
S20 3FR

+44 (0)114 251 1022

US

Evolution Power Tools LLC
8363 Research Drive
Davenport
Iowa
52806

+1 866-EVO-TOOL

EU

Evolution Power Tools SAS
61 Avenue Lafontaine
33560
Carbon-Blanc
Bordeaux

+33 (0)5 57 30 61 89



EPT QR CODE

